

User's Manual

MS Series



www.altoproaudio.com

Version 1.2 Nov. 2006

— English —

SAFETY INSTRUCTIONS



▲ "Electric discharge"

This symbol, alert you to the presence of uninsulated dangerous voltage inside the product enclosure, which constitutes a risk of electric shock.

▲ "Exclamatory point"

This symbol, alert the user to the presence of important operating and maintenance instructions in the owner's manual included to the product.



Disposing of this product should not be placed in municipal waste and should be Separate collection.

1. Read Instructions

All the safety and operation instructions should be read before using the product and retain them for future reference.

2. Water & Moisture

This product should not be used near water and will be protect from atmospheric agents in fixed or temporary installations.

3. Heat

This product should be situated away from heat sources such as radiators, or other devices which produce heat.

4. Liquid Entry

Care should be taken so that liquids are not spilled into the product and that objects do not fall on.

5. Service Assistance

This product should be serviced only by qualified service personnel when :

- a. Liquids has spilled or objects have fallen into this product, or
- b. This product has been exposed to rain, or
- c. This product does not appear to operate normally or exhibits change in performance, or has been dropped or its cabinet / chassis damaged.

6. Package

The package of this product has been tested, inspect the package before open, if any damage is found, notify to your dealer.

7. Hearing

This product produce high acoustic levels may cause permanent hearing loss, (SPL in for a defined period of time).

8. Installations

This product should be installed on the floor with a specific stand, according to the max weight, or in suspension with a five points included in the cabinet (M10 × 1.5PH Length 30mm).

The suspension of more speaker cabinet in a vertical array is NOT advised.

TABLE OF CONTENTS

- 1. INTRODUCTION.....3**
- 2. FEATURES.....4**
- 3. QUICK START.....5**
- 4. CONTROL ELEMENTS.....7**
- 5. INSTALLATION AND CONNECTION.....9**
- 6. TECHNICAL SPECIFICATION.....10**

1. INTRODUCTION

Thank you for purchasing ▲LTO MS series speaker system. This series includes MS series cabinet and ▲LTO MS1 speaker modeller.

MS series cabinet is specifically designed for use in hi-quality performance site and the precise sound reinforcement commercial place. It includes five full range cabinets (MS12, MS15, MS152, MS153, and MS154) and two subwoofers (MS15S, MS18S). This series uses trapezium configuration which greatly decreases the resonance of the standing wave in the cabinet. The cabinet uses hi-density matrix spray-paint technics and the bottom bracket design which makes mounting quickly and flexibly. HF compression driver and vented LF for fully professional performance.

▲LTO MS1 speaker modeller is designed for the use together with MS series cabinet. It has built-in 16 EQ curves which are suitable for different application and are convenient for users to select presets as need. When the non-professionals use it, they can obtain optimal effects. It uses external power which can effectively decreases the power noise. Not only can it be used with MS series cabinet, but also can be used as a EQ together with the other sound equipment.

Although the operation of MS series speaker system is very simple, to obtain the optimal effects please read this manual carefully before operation.

2. FEATURES

- Trapezium configuration decreases the resonance of the standing wave in the cabinet.
- The cabinet uses hi-density matrix spray-paint technics
- The bottom bracket design makes mounting quickly and flexibly.
- HF compression driver and vented LF for fully professional performance.
- Steep slope of 12dB/octave crossover for a cleaner signal with finer detail
- Built-in 16 EQ curves which are suitable for different application.
- external power which can effectively decreases the power noise

3. QUICK START

Make all initial connections with all the equipment powered off, and ensure that all the main volume controls are turned completely down.

- For Passive Full-range Speakers

- 1). Connect one side of the speaker cable to the OUTPUT CHA/CHB or Binding Post of your stereo power amplifier and the other side to the INPUT socket of your speaker cabinet.
- 2) Connect the input terminal of ▲LTO MS1 with the AUX SEND of mixer(or the similar terminal). Connect its output terminal with the AUX RETURN of the mixer. Then select the preset as need.
- 3). Complete other connections as illustrated.
- 4). Turn on your mixer and MS1 first, then the stereo power amplifier.
- 5). Turn up the volume controls of your amplifier to about 70%.
- 6). Use PFL function to get the proper input level for the mixer, and adjust the Main Mix Level control to manipulate the output level.
- 7). After using, turn off your stereo power amplifier first, then the mixer and Ms1.

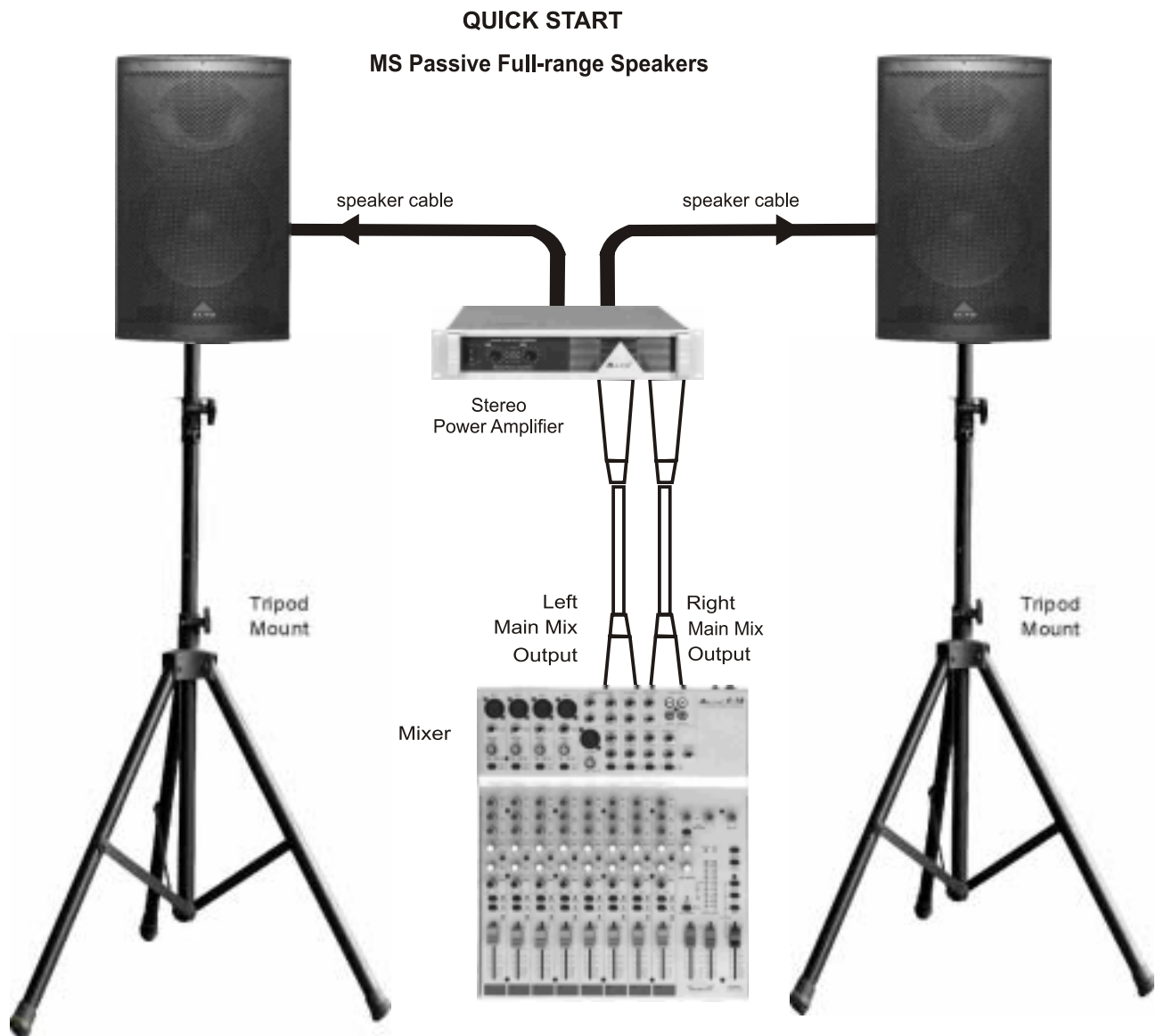

- For Passive Subwoofer & Satellite Speakers

- 1). Connect one side of speaker cable to the Output CHA/CHB or Binding Post of your stereo power amplifier and the other side to the Input socket of your subwoofer, with the second speaker cable connect the Output of the subwoofer to the Input of satellite.
- 2) Connect the input terminal of ▲LTO MS1 with the AUX SEND of mixer (or the similar terminal). Connect its output terminal with the AUX RETURN of the mixer. Then select the preset as need.
- 3). Complete other connections as illustrated.
- 4). Turn on your mixer and MS1 first, then the stereo power amplifier.
- 5). Turn up the volume controls of your amplifier to about 70%.
- 6). Use PFL function to get the proper input level for the mixer, and adjust the Main Mix Level control to manipulate the output level.
- 7). After using, turn off your stereo power amplifier first, then the mixer and Ms1.

QUICK START

MS Passive Subwoofer & Satellite Speakers

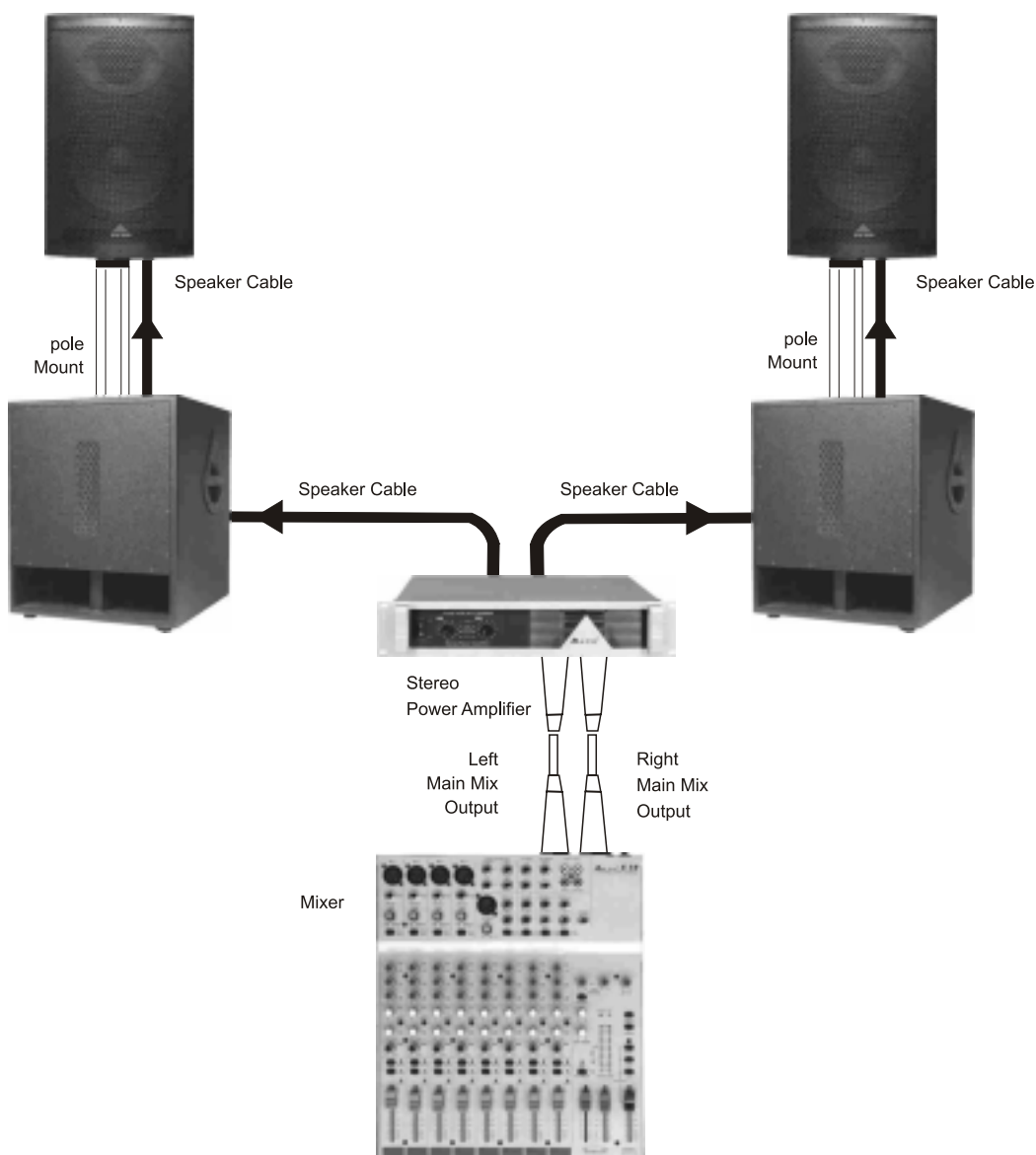

4. CONTROL ELEMENTS

4.1MS SERIES CABINET

- PASSIVE FULL-RANGE Speaker for MS12 / MS15 / MS152 / MS153/MS154

- (1) INPUT: Receive the power coming from an external power amplifier (SPK +1/-1 connected; +2/-2 not connected).
- (2) THRU: Direct LINK for connect in parallel a second speaker cabinet (SPK +1/-1 connected; +2/-2 not connected).

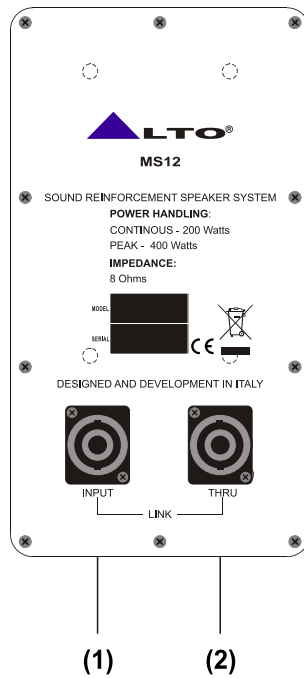

- PASSIVE SUBWOOFER Speaker for MS15S / MS18S

- (1) INPUT: Receive the power coming from an external amplifier (SPK +1/-1 connected; +2/-2 not connected).
- (2) OUTPUT: Power output for satellite speaker, under passive crossover filtered at 125Hz (SPK +1/-1 connected; +2/-2 not connected).

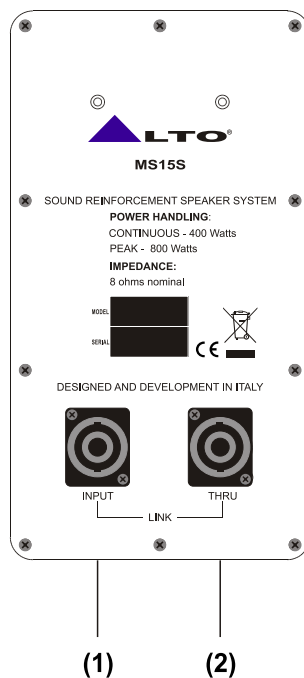

4.2 ▲LTO MS1 SPEAKER MODELLER

- THE FRONT PANEL

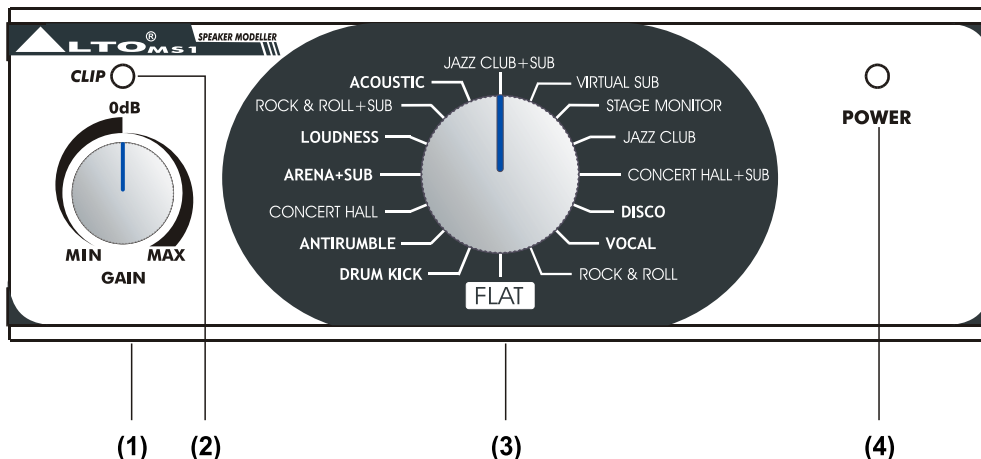

1. Gain Control

This control adjusts the input gain by a range of -20 dB to +20dB.

2. Clip LED

This LED lights up when the input signal is too strong. It warns that the output signal may cause distortion. Please attenuate the level of the input signal.

3. Presets Selector

Via this knob, you can select the right effect you wish to perform. There are total 16 options for you, JAZZ CLUB+SUB, VIRTUAL SUB, STAGE MONITOR, JAZZ CLUB, CONCERT HALL+SUB, DISCO, VOCAL, ROCK & ROLL, FLAT, DRUM KICK, ANTIRUMBLE, CONCERT HALL, ARENA+SUB, LOUDNESS, ROCK & ROLL+SUB and ACOUSTIC.

4. Power LED

This LED lights up when the unit is powered on.

-THE REAR PANEL

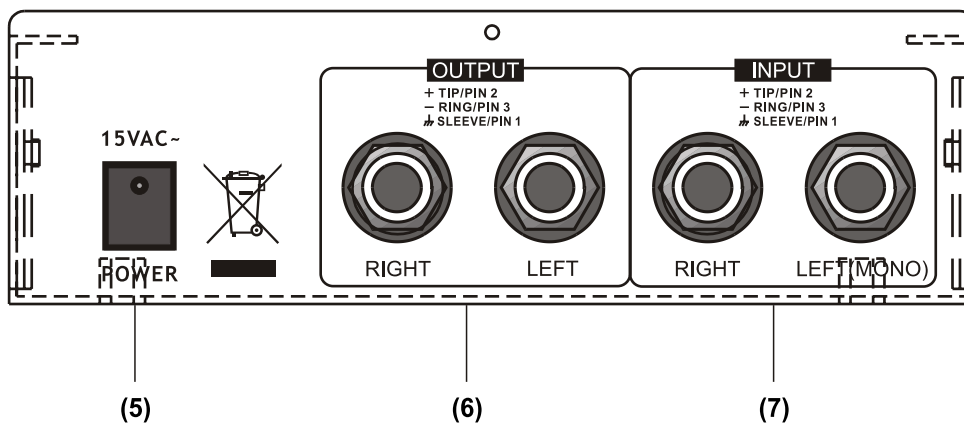

5. AC Inlet

This jack is used to connect the AC power supply with the supplied 15V AC adapter.

6. Output Connector

This is a balanced 1/4" TRS jack, which is used to connect devices such as the effects returns on a mixing console or power amplifier inputs.

7. Input Connector

This is a balanced 1/4" TRS jack, which connects to sources such as the effect sends of mixing console.

5. INSTALLATION AND CONNECTION

5.1 For MS Series Cabinets

Please use only the power connectors to make connections with other signal source equipment for the MS series cabinets. The power connector has four terminals: 1+, 1-, 2+, 2-.

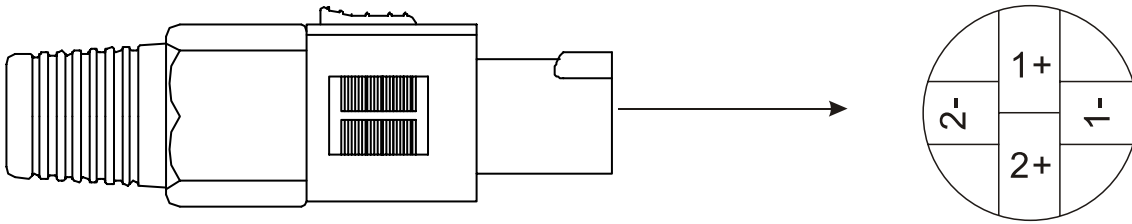

In our cabinets, only 1+/1- are used to connect the Speaker+/Speaker-, and 2+/2- are not used.

5.2 For ▲LTO MS1 SPEAKER MODELLER

Please use shielded twisting pair which can reduce noise and signal loss. The wiring of the connector is as follow

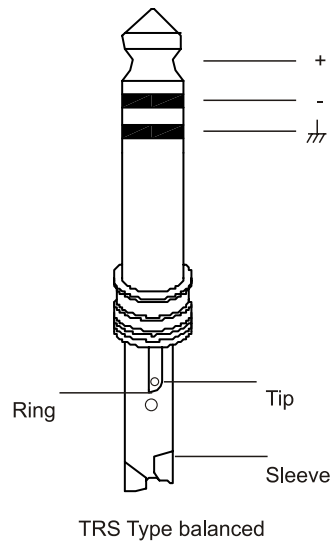

6. TECHNICAL SPECIFICATION

6.1 MS1 SPEAKER TECHNICAL SPECIFICATION

| Model Item | MS12 | MS15 |
|-----------------------|--|--|
| Passive System Type | 2-way vented box | 2-way vented box |
| Continuous Power | 200Watt AES Standard | 300Watt AES Standard |
| Peak Power | 400Watt Peak | 600Watt Peak |
| Max SPL at 1m | 119dB SPL calculated | 121dB SPL calculated |
| Frequency Response | 65Hz / 20kHz at -10dB | 60Hz / 20kHz at -10dB |
| Impedance | 8 Ohm | 8 Ohm / 4 Ohm |
| Crossover Frequency | 2k5Hz / 12dB/Oct | 2kHz / 12dB/Oct |
| Protection | Electronic Dynamic Protection | Electronic Dynamic Protection |
| Low Frequency Device | 12" woofer / 2" voice coil | 15" woofer / 2.5" voice coil |
| High Frequency Device | 1" Neodymium Driver / 1" voice coil | 1" Neodymium Driver / 1" voice coil |
| Coverage H° x V° | 90° H x 60° V Elliptical horn | 90° H x 60° V Elliptical horn |
| Connectors | 2 x SPK4 @ Power Input / Link | 2 x SPK4 @ Power Input / Link |
| Cabinet | Trapezoidal Shape / Composite Wood | Trapezoidal Shape / Composite Wood |
| | / Metal Handle / Black Paint finishing | / Metal Handle / Black Paint finishing |
| Dimensions H x W x D | H650 x W400 x D365 (mm) | H750 x W450 x D420 (mm) |
| Net Weight (lbs/kg) | 43.87lbs/19.90kg | 55.07lbs/24.98kg |

| Model Item | MS152 |
|-----------------------|---|
| Passive System Type | 2-way vented box |
| Continuous Power | 500Watt AES Standard |
| Peak Power | 1000Watt Peak |
| Max SPL at 1m | 123dB SPL calculated |
| Frequency Response | 55Hz / 20kHz at -10dB |
| Impedance | 4 Ohm |
| Crossover Frequency | 250Hz~2kHz / 12dB/Oct |
| Protection | Electronic Dynamic Protection |
| Low Frequency Device | 2 x 15" woofer / 2.5" voice coil |
| High Frequency Device | 1" Driver / 1.35" voice coil |
| Coverage H° x V° | 90° H x 60° V Elliptical horn |
| Connectors | 2 x SPK4 @ Power Input / Link |
| Cabinet | Trapezoidal Shape / Multi-layer Plywood |
| | / Metal Handle / Black Paint finishing |
| Dimensions H x W x D | H1100 x W450 x D443(mm) |
| Net Weight (lbs/kg) | 78.66lbs/35.68kg |

| | | |
|-----------------------|---|---|
| Model Item | MS153 | MS154 |
| Passive System Type | 3-way vented box | 3-way vented box |
| Continuous Power | 350Watt AES Standard | 700Watt AES Standard |
| Peak Power | 700Watt Peak | 1400Watt Peak |
| Max SPL at 1m | 123dB SPL calculated | 125dB SPL calculated |
| Frequency Response | 50Hz / 20kHz at -10dB | 45Hz / 20kHz at -10dB |
| Impedance | 8 Ohm or 4 Ohm | 4 Ohm or 8 Ohm |
| Crossover Frequency | 700Hz - 3kHz / 12dB/Oct | 700Hz - 3kHz / 12dB/Oct |
| Protection | Electronic Dynamic Protection | Electronic Dynamic Protection |
| Low Frequency Device | 15" woofer / 2.5" voice coil | 2 x 15" woofer / 2.5" voice coil |
| Mid Frequency Device | 8" midrange / 2" voice coil | 8" midrange / 2" voice coil |
| High Frequency Device | 1" Neodymium Driver / 1" voice coil | 1" Driver / 1.35" voice coil |
| Coverage H° x V° | 90° H x 60° V | 90° H x 60° V |
| Connectors | 2 x SPK4 @ Power Input / Link | 2 x SPK4 @ Power Input / Link |
| Cabinet | Trapezoidal Shape / Multi-layer Plywood | Trapezoidal Shape / Multi-layer Plywood |
| | / Metal Handle / Black Paint finishing | / Metal Handle / Black Paint finishing |
| Dimensions H x W x D | H900 x W450 x D415 (mm) | H1250 x W450 x D443 (mm) |
| Net Weight (lbs/kg) | 67.59lbs/30.66kg | 95.22lbs/43.19kg |

| Model Item | MS15S | MS18S |
|----------------------|-------------------------------------|-------------------------------------|
| Passive System Type | Band-Pass | Band-Pass |
| Continuous Power | 400Watt AES Standard | 400Watt AES Standard |
| Peak Power | 800Watt Peak | 800Watt Peak |
| Max SPL 1mt | 124dB SPL calculated | 124dB SPL calculated |
| Frequency Response | 45Hz / 200Hz at -10dB | 35Hz / 200Hz at -10dB |
| Impedance Low - High | 8 Ohm / 4 Ohm | 4 Ohm / 8 Ohm |
| Crossover Frequency | 250Hz Acoustical filter | 250Hz Acoustical filter |
| Low Frequency Device | 15" woofer / 3" voice coil | 18" woofer / 3" voice coil |
| Connectors | 2 x SPK4@Power Input / Output | 2 x SPK4@Power Input / Output |
| Cabinet | Multi-layer Plywood / Black painted | Multi-layer Plywood / Black painted |
| Dimensions H x W x D | H600 x W485 x D600 (mm) | H730 x W600x D600 (mm) |

7.2 ▲ALTO MS1 TECHNICAL SPECIFICATION

| | | |
|------------------------------|-----------------------|--|
| AUDIO INPUT | Connectors | 1/4" jack |
| | Type | RF filtered, servo balanced input |
| | Impedance | 30 Kohm balanced, 22 Kohm unbalanced |
| | Max. input level | +26 dBu balanced and Unbalanced |
| | CMRR | Typ.40db,>55db@1khz |
| AUDIO OUTPUT | Connectors | 1/4" jack |
| | Typebalanced | |
| | Min. output impedance | 100 Ohm |
| | Max. output level | +26 dBu balanced |
| SYSTEM SPECIFICATIONS | Frequency response | 10Hz to 30kHz, +/-1dB(FLAT) |
| | S/N | >110dB, unweighted, 22 Hz to 22kHz |
| | THD | 0.005% typ.@0 dBu, 1kHz,(unity gain), FLAT |
| INDICATORS | Input level | CLIP LED display: +7dbu |
| POWER SUPPLY | AC ADAPTOR | USA/Canada 120V~, 60Hz |
| | | U.K./Australia 240V~, 50Hz |
| | | Europe 230V~, 50Hz |
| | Power consumption | 5W |
| PHYSICAL | Dimension | 130(W)x117(D) x45(H)mm(5.1"x4.6"x1.7") |
| | Net weigh | 0.8kg |

SEIKAKU TECHNICAL GROUP LIMITED
No. 1, Lane 17, Sec. 2, Han Shi West Road, Taichung 40151 Taiwan
<http://www.altoproaudio.com> Tel: 886-4-22313737
email: alto@altoproaudio.com Fax: 886-4-22346757

All rights reserved to ALTO. All features and content might be changed without prior notice. Any photocopy, translation, or reproduction of part of this manual without written permission is forbidden. Copyright © 2006 SEIKAKU GROUP